

8 7 6 5 4 3 2 1

F

F

E

E

D

D

C

C

B

B

A

A

8 7 6 5 4 3 2 1

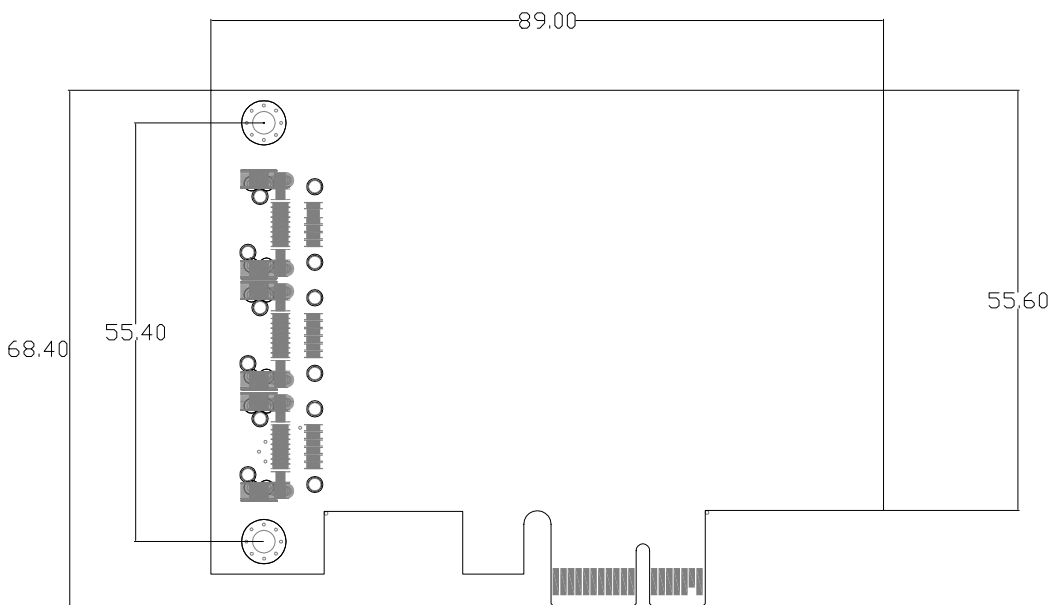

THIRD ANGLE PROJECTION

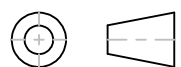

GENERAL NOTES

DIMENSIONS ARE IN MM - DO NOT SCALE

THIS DOCUMENT CONTAINS CONFIDENTIAL,
 PROPRIETARY INFORMATION THAT IS
 PROPERTY OF STARTECH.COM



PRODUCT ID	PEX1394A2V2 - PCB Board		
DESCRIPTION	2-Port PCI Express FireWire Card - PCIe FireWire 1394a Adapter		
DO NOT SCALE	SHEET: 1 OF: 3	UPLOAD DATE: 09/02/2020	

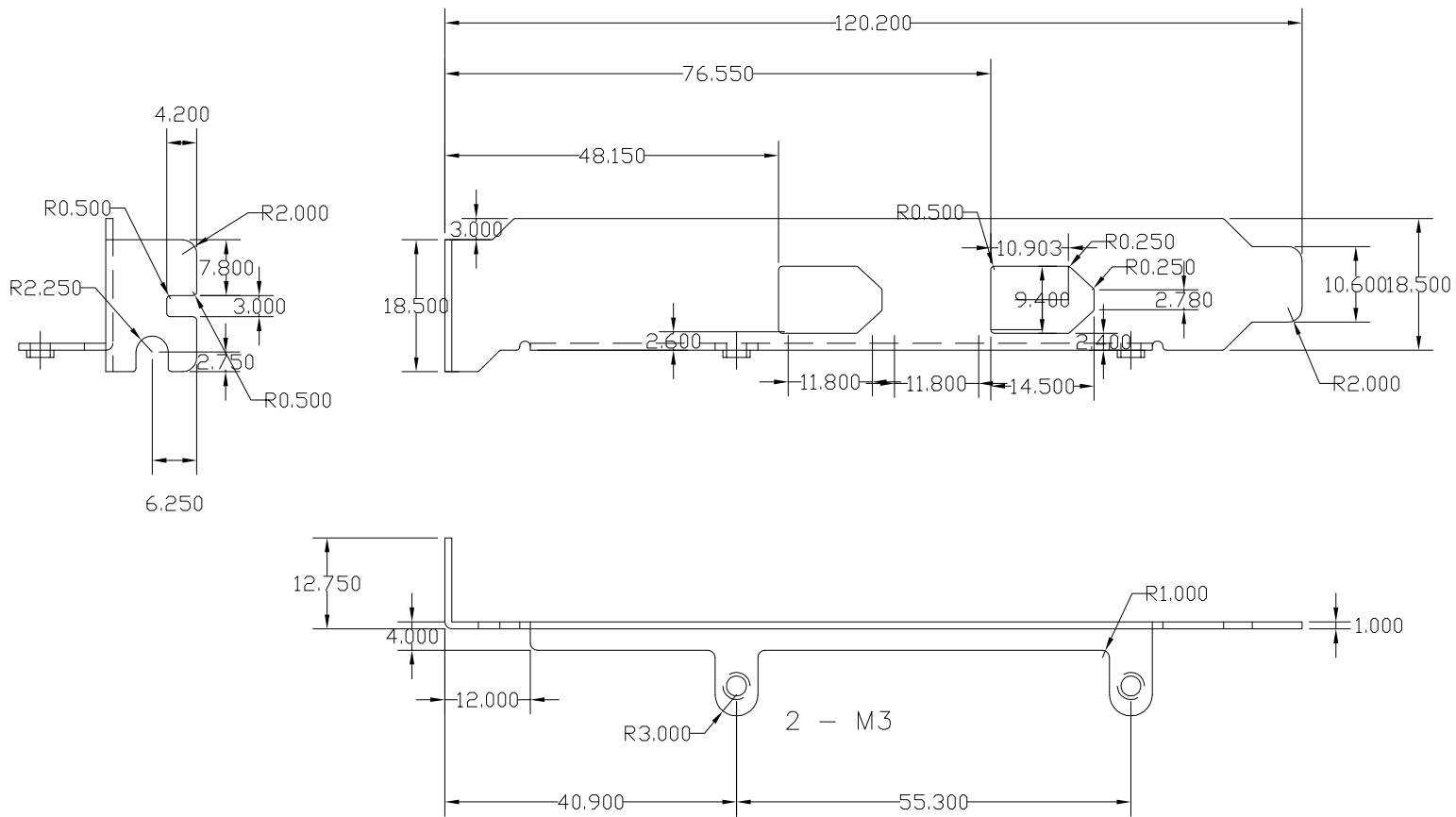

THIRD ANGLE PROJECTION

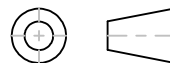

GENERAL NOTES

DIMENSIONS ARE IN MM - DO NOT SCALE
 THIS DOCUMENT CONTAINS CONFIDENTIAL,
 PROPRIETARY INFORMATION THAT IS
 PROPERTY OF STARTECH.COM

StarTech.com

PRODUCT ID	PEX1394A2V2 - Standard Bracket		
DESCRIPTION	2-Port PCI Express FireWire Card - PCIe FireWire 1394a Adapter		
DO NOT SCALE	SHEET: 2 OF: 3	UPLOAD DATE: 09/02/2020	

8 7 6 5 4 3 2 1

F

E

D

C

B

A

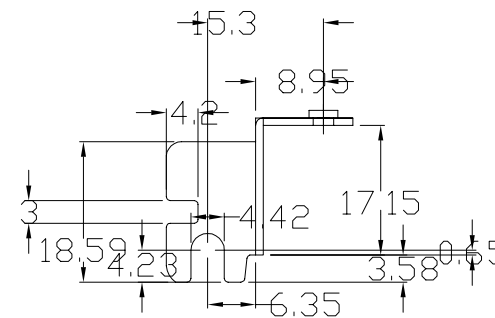
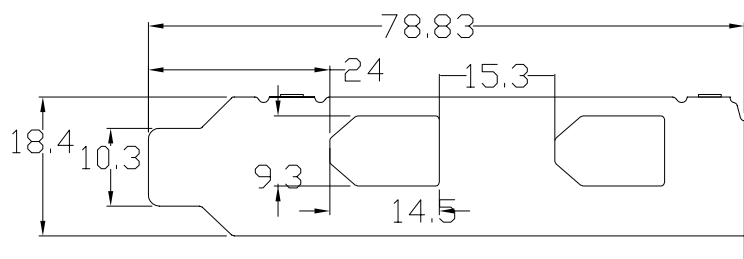
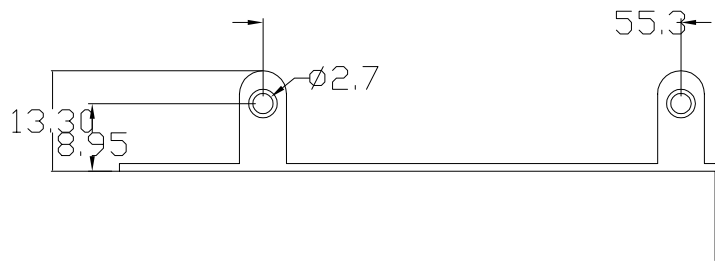

THIRD ANGLE PROJECTION

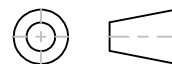

GENERAL NOTES

DIMENSIONS ARE IN MM - DO NOT SCALE

THIS DOCUMENT CONTAINS CONFIDENTIAL, PROPRIETARY INFORMATION THAT IS PROPERTY OF STARTECH.COM

StarTech.com

PRODUCT ID	PEX1394A2V2 - Low Profile Bracket		
DESCRIPTION	2-Port PCI Express FireWire Card - PCIe FireWire 1394a Adapter		
DO NOT SCALE	SHEET: 3 OF: 3	UPLOAD DATE: 09/02/2020	

8 7 6 5 4 3 2 1